

A

B

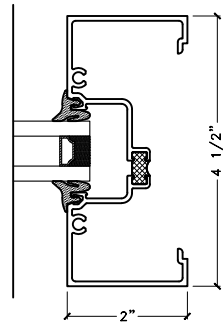

Kawneer 451-T
Fixed Window
1W x 2H

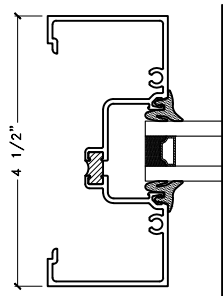
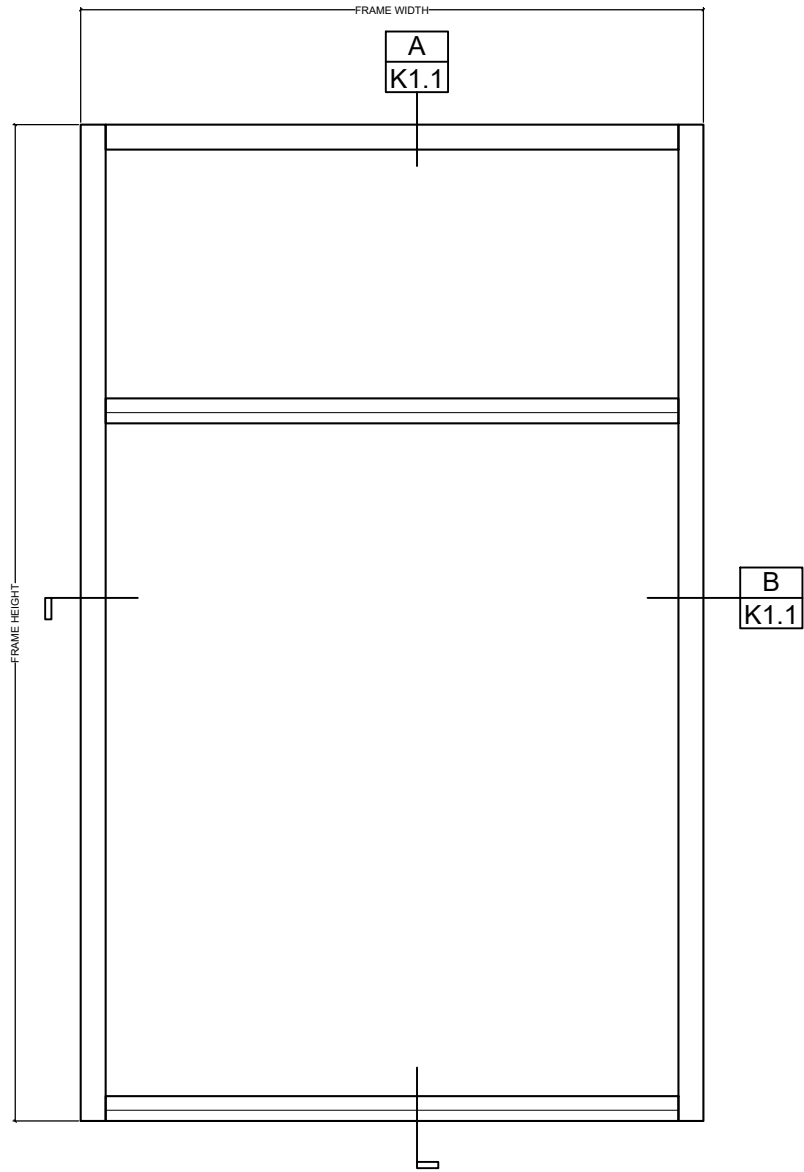

DRAFTER: W.A.G.	SCALE: N.T.S.	DATE: 7.29.19
--------------------	------------------	------------------

DRAWING NUMBER:
K1.1

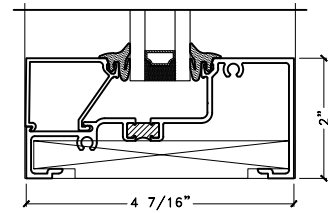
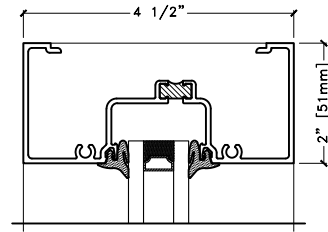

A

B

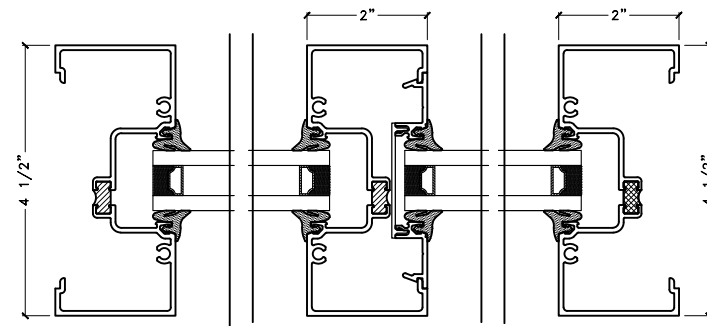
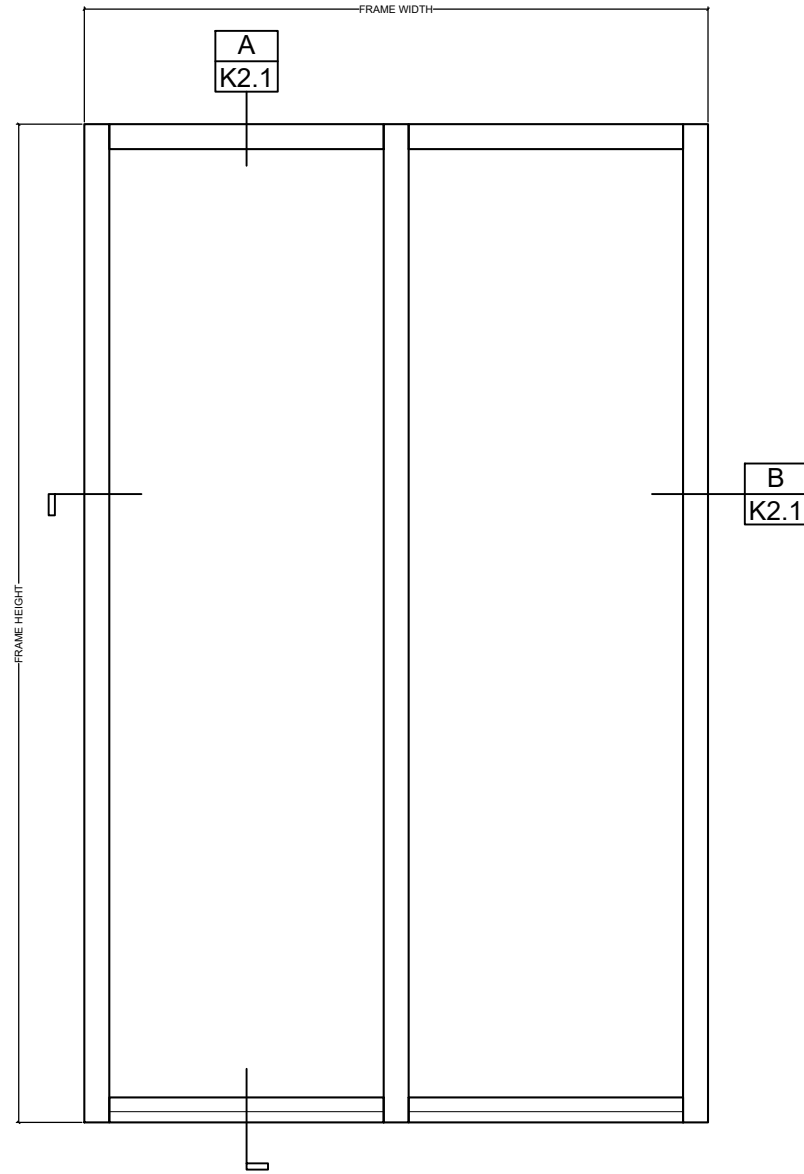

Kawneer 451-T
Fixed Window
2W x 1H



DRAFTER: W.A.G.	SCALE: N.T.S.	DATE: 7.29.19
--------------------	------------------	------------------

DRAWING NUMBER:
K2.1

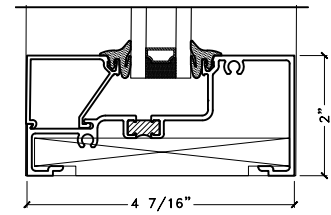
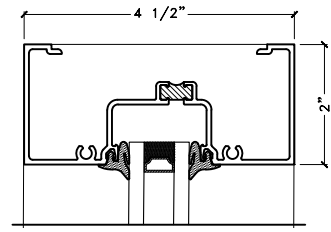

A

B

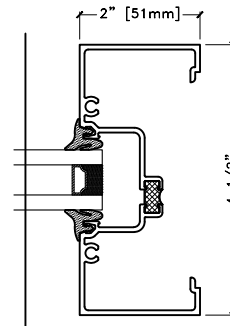
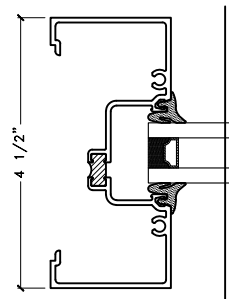
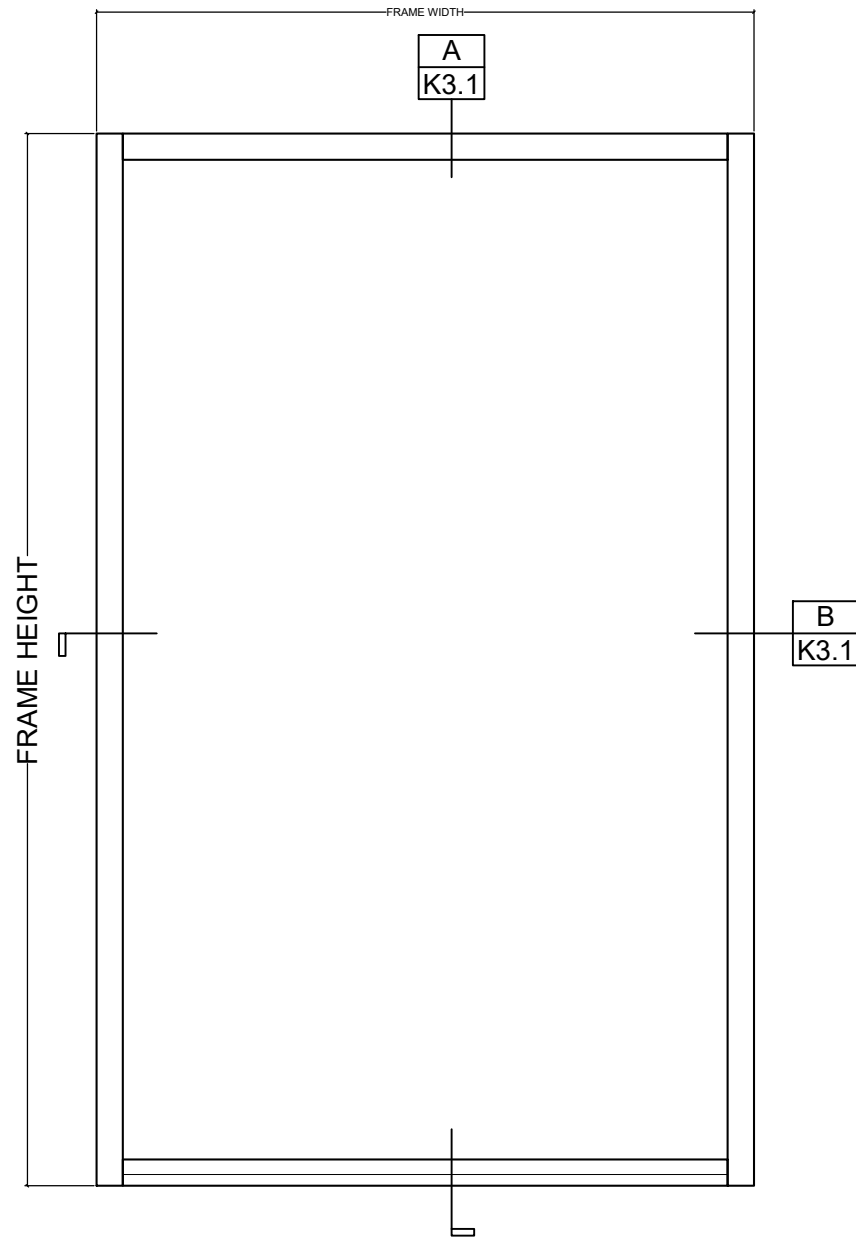

Kawneer 451-T
Fixed Window
1W x 1H



DRAFTER: W.A.G.	SCALE: N.T.S.	DATE: 7.29.19
--------------------	------------------	------------------

DRAWING NUMBER:
K3.1